



THE WORLD LEADER IN
FUME EXTRACTION TECHNOLOGY

AD 500 iQ

USER MANUAL



Contents

1

- 01 Overview of your iQ extraction system (front)
- 02 Overview of your iQ extraction system (back)
- 03 Overview of LCD display

2

- 01 Important safety notes
- 02 Safety labels

3

- 01 Unpacking and unit placement

4

- 01 Fume capture methods
- 02 Connecting to power supply
- 03 Optional added features
- 04 Optional added features (cont'd)
- 05 Optional added features (cont'd)

5

- 01 Turning extractor on / Changing display units
- 02 Setting the airflow
- 03 Airflow auto adjust (first installation only)

6

- 01 Cleaning the unit / Pre filter replacement
- 02 Combined filter replacement

7

- 01 iQ display features / Visual alarms
- 02 Visual alarms (cont'd)
- 03 USB connectivity / USB upload
- 04 USB download
- 05 Information collected by USB

8

- 01 Fault indication / Error codes

9

- 01 Consumables spares/filter disposal

10

- 01 AD 500 iQ specifications

Overview



1 01

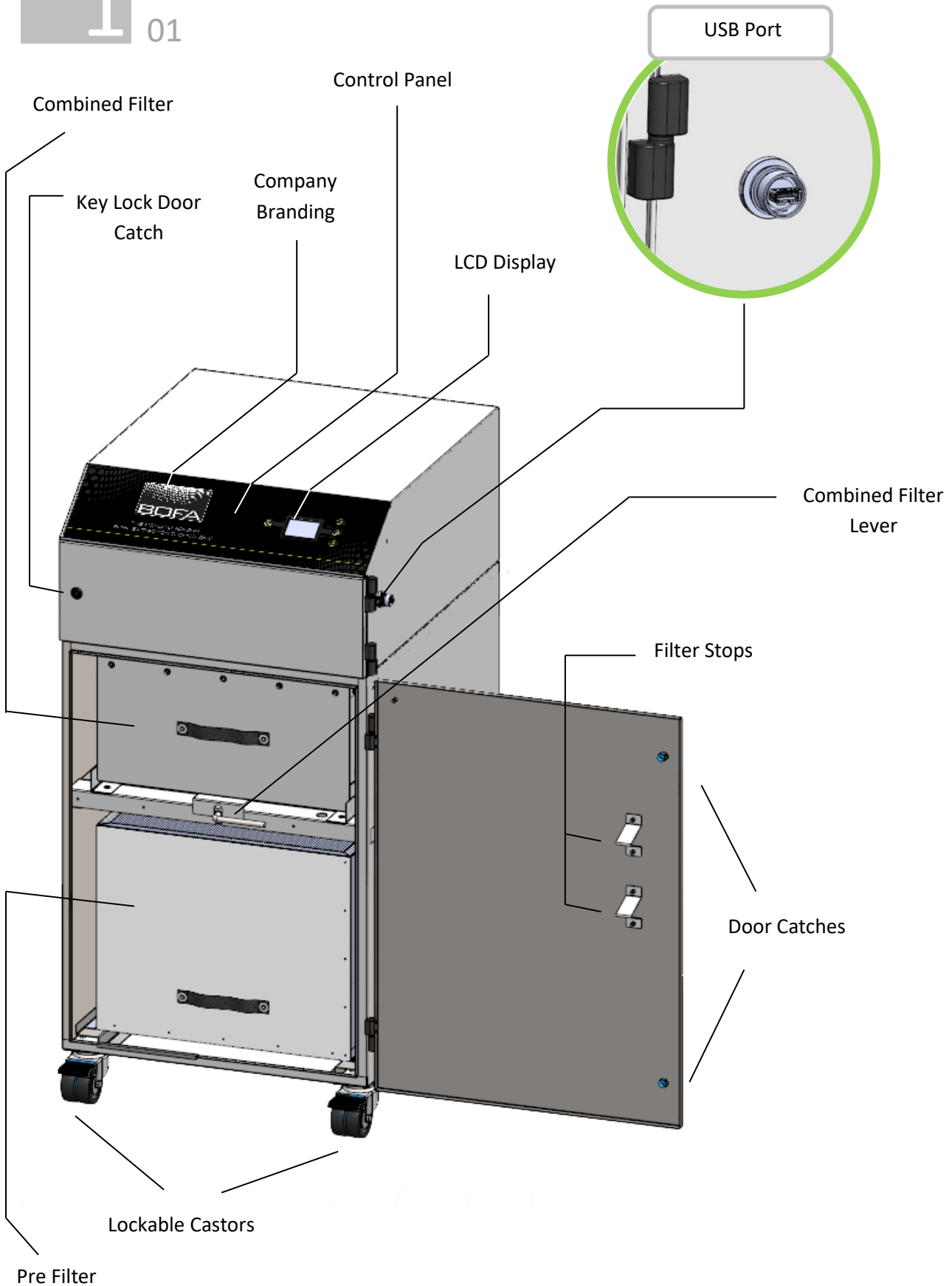

Overview

1 02



Compressor Connection
(Optional)

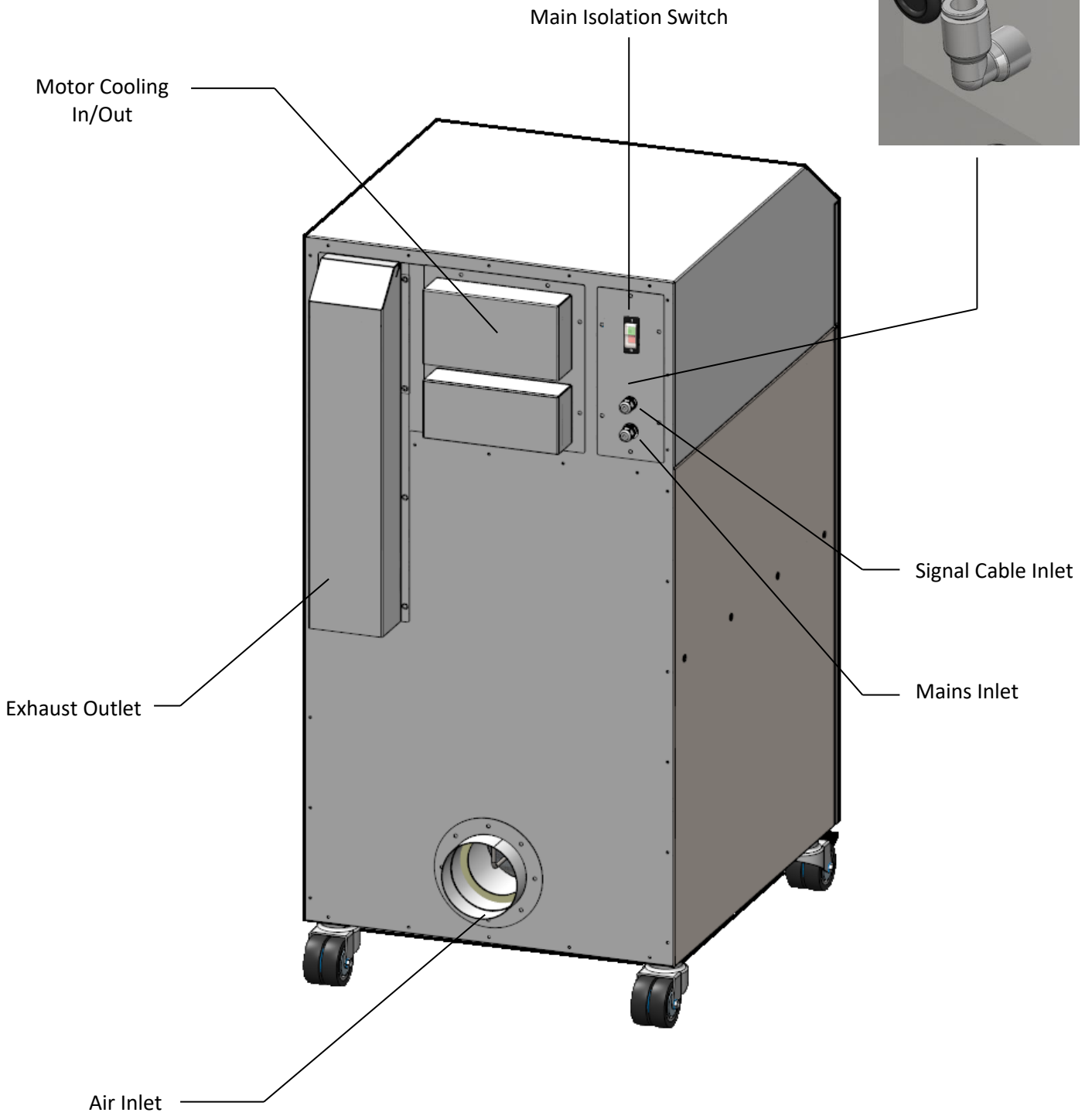

Overview

1 03



iQ

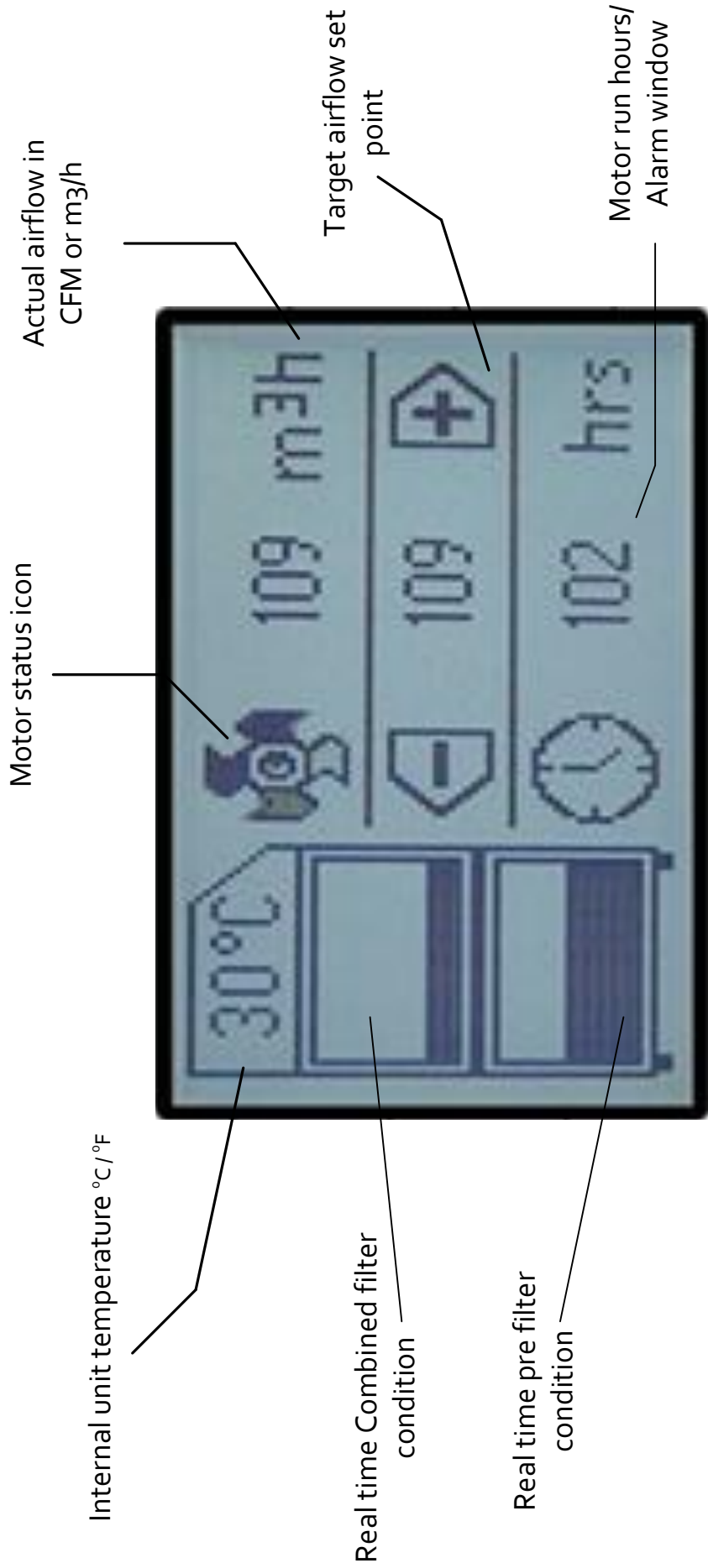

Safety Instructions



Important safety notes

Concerning symbols used on the extraction unit and referred to within this manual.



Danger

Refers to an immediately impending danger. If the danger is not avoided, it could result in death or severe (crippling) injury. Please consult the manual when this symbol is displayed.



Warning

Refers to a possibly dangerous situation. If not avoided it could result in death or severe injury. Please consult the manual when this symbol is displayed.



Caution

Refers to a possibly harmful situation. If not avoided, damage could be caused to the product or something in its environment.



Important (Refer to manual)

Refers to handling tip and other particularly useful information. This does not signify a dangerous or harmful situation. Refer to manual when this symbol is displayed.

Electrical Safety

The AD 500 iQ system has been designed to meet the safety requirements of the Low Voltage Directive 2006/95/EC (previously numbered 73/23/EEC)

Warning

When working with the pump/motor housing open, Live 230/115 volt mains components are accessible. Ensure that the rules and regulations for work on live components are always observed.

Important

To reduce the risk of fire, electric shock or injury:

1. Always isolate the system from the mains power supply before removing the pump/motor access panel.
2. Use only as described in this manual.
3. Connect the system to a properly grounded outlet.

Dangers to eyes, breathing and skin

Once used, the filters within the AD 500 iQ system may contain a mixture of particulates, some of which may be sub-micron size. When the used filters are moved it may agitate some of this particulate, which could get into the breathing zone and eyes of the operative. Additionally, depending on the materials being processed, the particulate may be an irritant to the skin.

This unit should not be used on processes with sparks of flammable materials or with explosive dusts and gases, without implementation of additional precautions.

Caution: When changing used filters always wear a mask, safety shoes, goggles and gloves.

Carbon selection

Please note that the media within the gas filter fitted in the AD500 iQ is capable of adsorbing a wide range of organic compounds. However, it is the responsibility of the user to ensure it is suitable for the particular application it is being used on.

BOFA Technical Service

If a problem arises with your AD 500 iQ system, or if it displays a fault code, please refer to the troubleshooting guide section 8 of this manual. If the problem is still not resolved, please:

- Visit our website at www.bofa.co.uk for on-line help.
- Or contact the helpline on **+44 (0) 1202 699 444**, Mon-Fri, 9am-5pm.
Email: Technical@bofa.co.uk

Serial Number

For future reference, fill in your iQ system details in the space provided. The serial number is on the rating label located on the side/rear of the unit.

Serial Number:

□	□	/	A	D	-	5	0	0	I	Q	□	□	□
---	---	---	---	---	---	---	---	---	---	---	---	---	---

Safety Instructions



Warning and Information labels

The following listing details labels used on your AD 500 iQ unit.

Goggles, Gloves & Mask Label



Location: Front face of both filters

Meaning: Goggles, Gloves and Masks should be worn while handling used filters.

Do Not Cover Label



Location: Rear lower access panel and Left side of unit below sensor port.

Meaning: Do not cover any louvers or holes adjacent to the label.

Electrical Danger



Location: Rear upper & lower access Panels and internal motor access panel.

Meaning: Removal of panels with this label attached will allow access to potentially live components.

Warning Label



Location: Top left front door panel.

Meaning: Power should be isolated before the panel with this label attached is opened/ removed.

Serial Number Label



Location: Top right on the right hand side panel.

Meaning: This label contains a variety of information about the extraction unit, including.

- Company name, Address & Contact number
- Extractor model
- Unit serial number
- Operating voltage range
- Maximum current load
- Operating frequency
- Year of Manufacture
- Relevant approval markings/ logos

PLEASE NOTE: If the equipment is used in a manner not specified by the manufacturer, the protection provided by the equipment maybe compromised.

Fire Risk Warning

In the very rare event that a burning ember or spark is drawn into the fume extraction unit, it may be possible that the filters will ignite. Whilst any resultant fire would typically be retained within the fume extraction unit, the damage to the extractor could be significant.

It is therefore essential to minimise the possibility of this occurring by undertaking an appropriate Risk assessment to determine:

- a). Whether additional fire protection equipment should be installed.
- b). Appropriate maintenance procedures to prevent the risk of build-up of debris which could potentially combust.

This unit should not be used on processes where sparks could occur, with explosive dusts and gases, or with particulates which can be pyrophoric (can spontaneously ignite), without implementation of additional precautions

It is essential that nozzles or other extraction/ fume capture devices and hoses/pipework are cleaned regularly to prevent the build-up of potentially ignitable debris

Before installation

3₀₁

Inner transit packaging removal & unit placement

Before installation, check the extraction unit for damage. All packaging must be removed before the unit is connected to the power supply.

Please read all instructions in this manual before using this extractor.

1. Move the unit to the location where it is going to be installed and remove the outer packaging. **This unit should be installed in a well-ventilated area.**
2. Open the front door and remove the transit foam from the centre of the unit.



 **Caution**

Due to the weight of the extractor suitable lifting equipment should be used and with regard to appropriate safety precautions. (See Appendix for product weight details)

Ensure that 500 mm space is available around any vented panels on the extractor to ensure adequate airflow.

3. With the unit in position lock the 2 front castors.

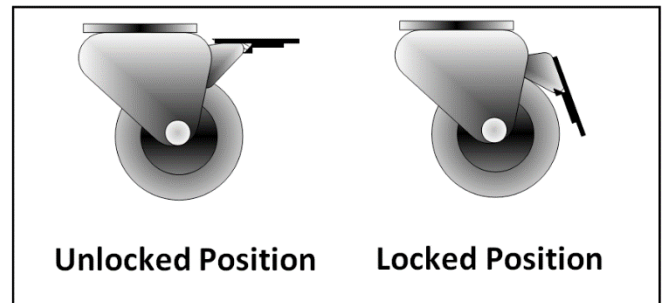

Caution

Do not block or cover the cooling vents on the unit, as this  severely restricts airflow and may cause damage to the unit.

Caution

Under no circumstances should the exhaust outlet/s be  covered as this will restrict the airflow and cause overheating.

4. Check the filters are located in their correct position before closing the door and securing the door latches.

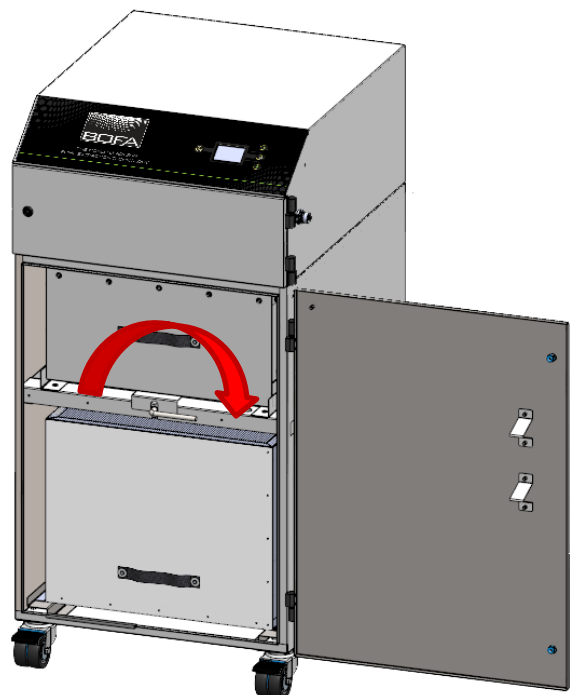

Installation

4 01

The AD500 iQ has been designed to remove and filter fume containing potentially hazardous particulate and gases generated during manufacturing processes. Such hazardous substances are captured within a multistage filtration system after which the cleaned air is returned to the workplace.

Fume Capture Methods

The fume is normally captured by 1 of 3 methods.

- Flexible arm/ Nozzle
- Enclosures
- Cabinets

General Guidelines for a successful installation

- Keep duct run length to a minimum
- Avoid sharp bends / turns in the ductwork
- Avoid multiple bends / turns in the ductwork
- Use a larger diameter duct where able
- Position the capture device as close as possible to the marking point. (if used on high speed lines, position the capture device slightly downstream)

Flexible Arm & Nozzle Extraction

The stay put arm should be mounted as close as possible to the marking point using the horseshoe clips. Unscrew the push fit connector from the other side of the flexible hose. Cut the flexible hose to suit the distance back to the extractor connection and push onto the extractor inlet.

Purge air should be kept to a minimum, where possible, to prevent the fume being blown away from the nozzle. High speed bottling lines may need bigger scoops or nozzles both sides of the bottles because of the turbulence caused by the speed of the bottles.

Moving products

For applications where the product to be marked is moving past the stationary laser head the capture nozzle should be positioned as close as possible to the marking area on the side the product is moving towards.

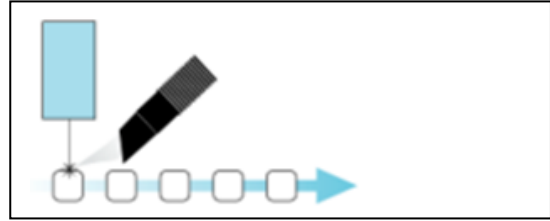

Enclosures

The extraction hose and nozzle can be attached to the enclosure surrounding the marking zone provided that the extraction point is within 50-75mm of the marking point.

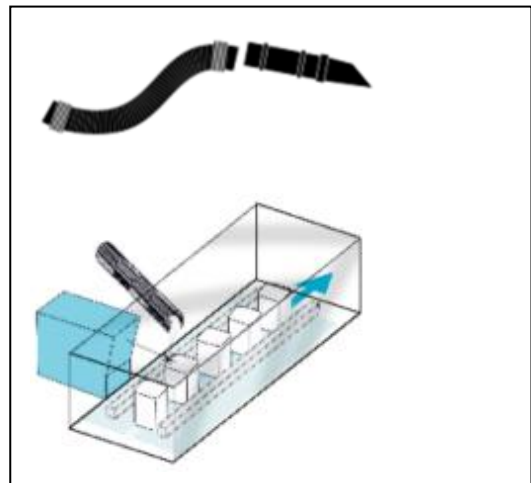

Cabinets

Cabinets normally have a 75mm or 100mm spigot for fume extraction. For best performance use the same diameter hose as the spigot and reduce at the extractor end if necessary. **Keep the hose run as short as possible.**

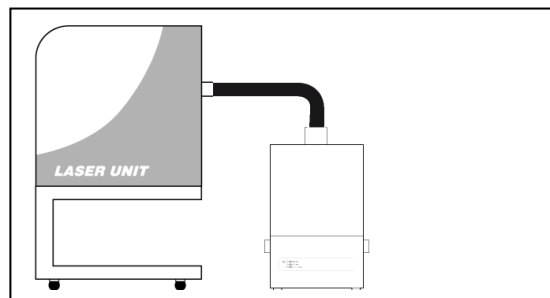

Connection to extraction unit

All ductwork should be installed and connected to the extraction unit before the iQ system is turned on.

Exhausting filtered air outside

If requested your iQ extraction unit will have been fitted with an exhaust outlet spigot. This provides a connection point for exhaust pipework to be fitted. It is important to keep any ducting to a minimum, in order to reduce back pressure within the system.

Installation



Specification

Dimensions: Height 1201mm Depth 787mm Width 617mm

Weight: 142.7Kg

Voltage & Current: 115V/14.8A 230V/9.5A

Frequency: 50/60Hz

Power: 1100w

Capacity: 550m³/h

Maximum Altitude: 2000m

Connection to Power Supply

Please follow the above specification when selecting the power supply outlet for the iQ system, ensure the power supply is suitable before connecting the iQ system.

Check the Integrity of the electrical power cable, if the supply cord is damaged the extraction unit should not be connected to the mains. The supply cord should only be replaced by a BOFA engineer as an electrical safety test may be required after replacement.



The iQ system **MUST** be connected to a properly earthed outlet.



If your iQ system was ordered with any optional extras please read section 4.03 before the power connection is made as additional connections may be required before power is connected to the extractor.

Connect the power cable to an isolated electrical supply.

The mains socket should be installed near the extractor it should be easily accessible and able to be switched On/ Off. The cable run should be arranged so as not to create a trip hazard.

This equipment shall be mounted in accordance with local regulation.

Installation

4 03

Optional added features

The AD 500 iQ can be configured to suit customer specification. These optional extras would be discussed, arranged and installed prior to delivery.

(If unsure what features your iQ system is equipped with please contact the seller with the unit serial number, (Refer to section 2 for location) who will be able to advise what specification has been supplied.

Remote Stop/Start feature

Enables the extraction unit to be remotely turned On / Off via an external signal.

This feature can be configured in 3 ways

- DC Voltage input – Range 12-24VDC
- Volt free input – Open / Closed contacts
- Override – Stop / Start feature switched off

Note: Care must be taken to ensure that the system is correctly wired in order for the extraction unit to function correctly.

DC Voltage input

This configuration requires the Black & Red cores of the signal cable (Refer to section 1 for location) to be connected to a known and tested DC power supply, in order to start the extractor.

The operating voltage for this signal is between 12 & 24VDC. Only voltages within this range should be connected. Voltages connected outside of this range may cause irreversible damage to the internal control PCB.

Red cable = V+

Black cable = V-

When the extractor is provided with the correct DC voltage the motor will start and maintain the set flow rate (Refer to section 5 for how to set the flow) when the DC voltage is removed the motor will slow down and come to a stop.

The extractor will need to be turned on and be out of standby mode (See section 5 for turning the extractor on) in order for this feature to operate.

Volt free input

This configuration requires the Black & Red cores of the signal cable (see section 1 for location) to be connected together, in order to start the extractor.

When the 2 cables are connected together the motor will start and maintain the set flow rate (see section 5 for how to set the flow)

when the 2 cables are disconnected the motor will slow down and come to a stop.

The extractor will need to be turned on and be out of standby mode (See section 5 for turning the extractor on) in order for this feature to operate.

Override

Enables the extractor to operate fully with or without either DC voltage input or the Volt free input.

The override feature can be toggled On / Off by a switch mounted on the internal motor access panel (see below for switch location)

Switch in "On" position

In this position the extractor will require a start signal (either Voltage input or Volt free, depending on the requested specification) to enable the motor within the extraction unit.

Switch in "Off" position

In this position the extractor motor will run without the requirement for an external start signal. This feature is useful for engineers carrying out works/ tests on the extractor without the need for the laser / auxiliary signal being present.

The power supply unit which is used to provide the 12-24VDC start stop voltage signal must be protected by double insulation from mains voltage.

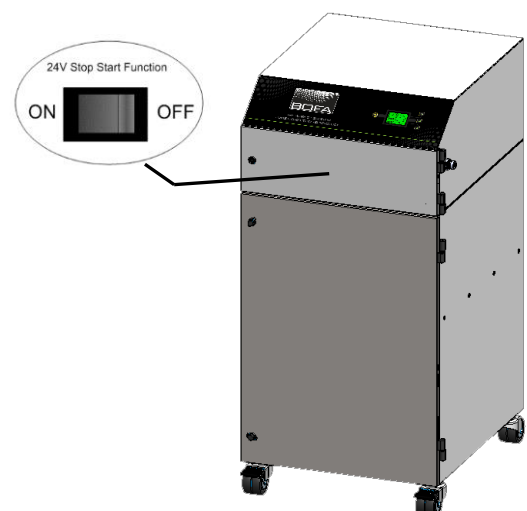

Installation

4 04

Filter Blocked / System Fail Signal

With this option the iQ system will output a signal to alert the user when the extractor has failed or when the filters are blocked.

This feature will not directly stop the extractor from running correctly, but if fitted this feature should be terminated correctly before power is applied to the iQ system.

Connection specification

This signal is available via the Green and White cores of the signal cable. The iQ system will provide a volt free Open / Closed signal that can be connected to an external interface, beacon or warning device following the specification below.

- **Maximum input voltage: 24V AC**
- **Maximum current load: 3A @ AC**
OR
- **Maximum input voltage: 24V DC**
- **Maximum input load: 3A @ DC**

Filter Signal Configurations

There are 3 ways this signal can be configured, as detailed below.

- **Combined signal (standard specification)**
- **Separated signal**
- **Reversed separated signal**

Combined signal

With this configuration the Filter blocked & System fail signals will be linked together to give a combined single output.

When the filters become blocked or the iQ system develops a fault (Refer to section 8 for Troubleshooting & Error codes) the connection between the Green & White cables will become "Open"

When the extraction system is running normally the connection between the Green & White cables will become "Closed"

Separated Signal

With this configuration the Filter blocked & System fail signals will be separated to give 2 individual signals.

When the filters become blocked the connection between the Green & White cables will become "Open"

If the iQ system develops a fault (Refer to section 8 for Troubleshooting & Error codes) the connection between the Blue & Yellow cables will become "Open"

When the extraction system is running normally the connection between the (Green / White) & (Blue / Yellow) cables will become "Closed"

Reversed Separated Signal

With this configuration the cable function will remain the same as the **Separated signal** option, but the signal given will be reversed.

For blocked filters the connection between the cable cores will be "Closed"

For iQ system faults the connection between the cable cores will be "Closed"

For system OK the connection between the cable cores will be "Open"

Combined Signal

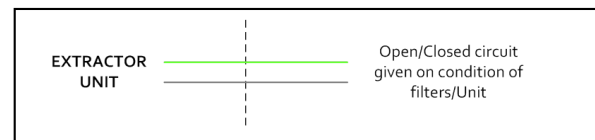

Separated Signal

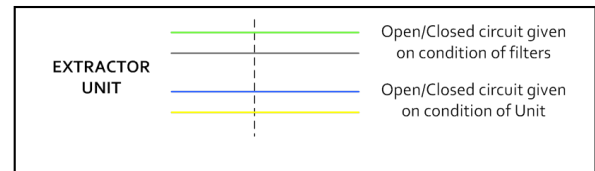

Compressor option

If a compressor has been fitted to the extraction unit, connect the compressor hose, to the extractor compressor outlet (Refer to section 1 for location) and connect the opposite end to the laser. Refer to laser installation instructions. A water trap should be fitted to the Laser end of the pipework.

Installation

4₀₅

Optional Added Feature: Door and Pre Filter Interlock

With this option the iQ system will not function if the front door has been left open. There is a switch located on the internal cam shelf next to the combined filter handle. To enable the iQ system to function, the front door must be closed and the latches secured.

A second switch is located in the iQ extraction unit behind the pre filter.

If there is no pre filter fitted, the iQ system will prevent the extraction unit from starting up. A pre filter will need to be installed (see section 6.02) and the front door closed before the unit is able to start.

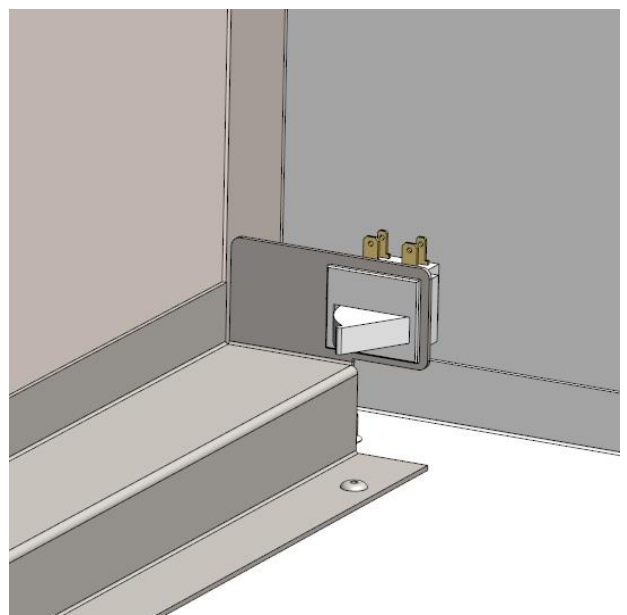
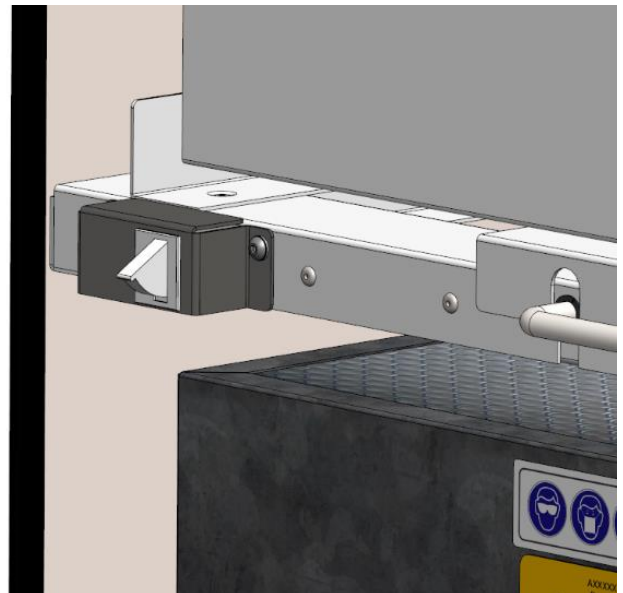
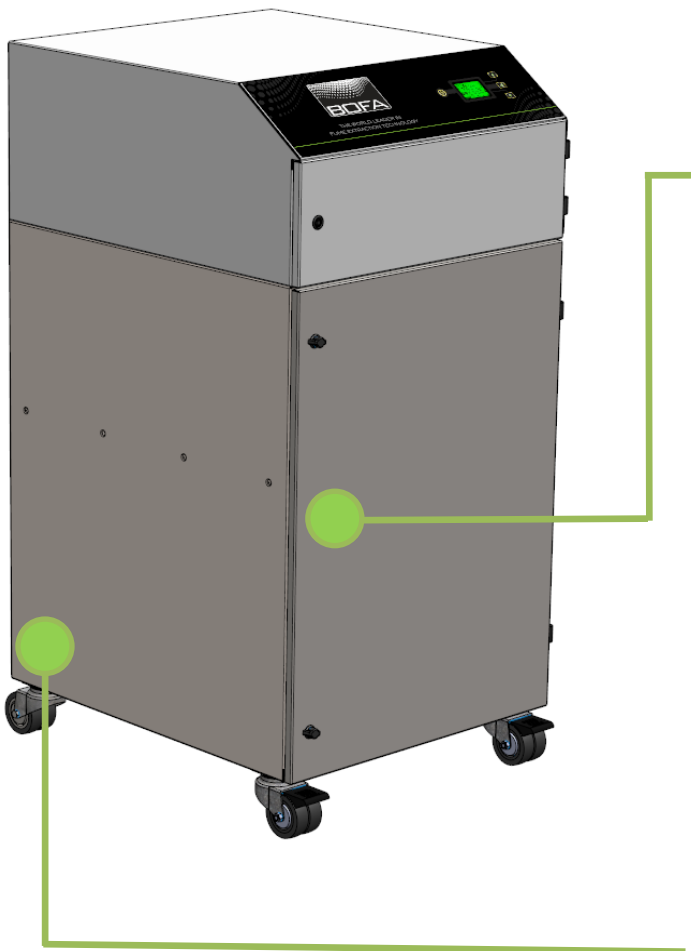

Operation



Turning extraction unit On

There are 2 stages to powering up your iQ extraction unit. Firstly the main isolation switch must be switched to the "On" position (Refer to section 1 for switch location) by depressing the Green side / (I) of the switch. This will place the extraction unit in Standby mode, indicated by the front panel power button glowing Red. If the AD 500 iQ has a powder coated finish then the top side of the switch should be depressed to power the unit.

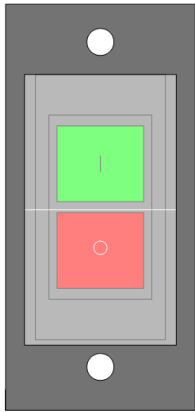

Stainless Steel

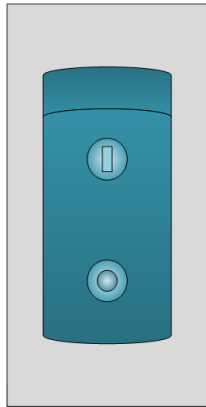

Powder Coated

To start the extraction unit press the front panel power button (refer to section 1 for switch location) the button will change from Red to Green indicating the extraction unit is now fully On.

It is recommended that the rear isolation switch is left in the On position and the front standby switch is used to toggle the extractor On / Off.

Standby

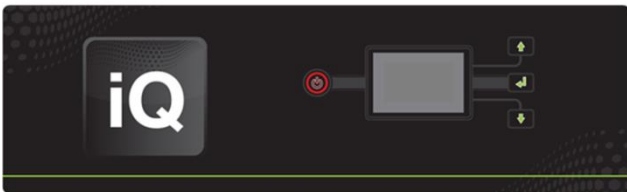

On



Changing the display units

The Airflow and temperature readings can be displayed in 2 ways.

1. Temperature displayed as °C
Airflow displayed as m³/h
OR
2. Temperature displayed as °F
Airflow displayed as CFM

The display value can be changed by pressing the "Enter" button once.

1)

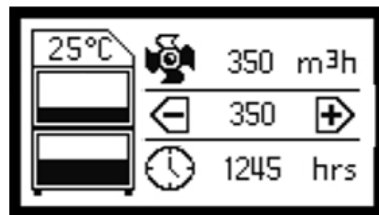

2)

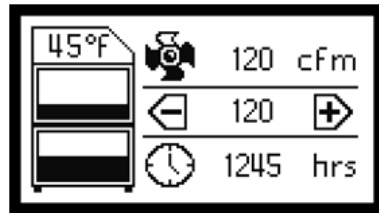

Operation

5₀₂

Setting the desired airflow

The iQ system features automatic flow control. This enables the user to set the required airflow rate, then over time as the filters begin to block the motor will automatically begin to increase in speed to compensate for any loss in performance caused by the added restriction of the partially blocked filters.



The extractor and all pipe work must be fully installed and connected before the airflow is set.

To set the airflow

(The airflow can be set between 150-550m³/h)

1. Press and hold the "Enter" (middle) button (Refer to section 1 for button location) for 3 seconds, or until all 3 button lights flash green.
2. Release the Enter button, the iQ system is now in set mode. Press either the Up or Down button to adjust the airflow accordingly. Real time airflow is displayed on the LCD screen, Refer to section 1 for Display information)
3. Once you have your desired airflow, leave the controls, after around 10seconds the flashing buttons will illuminate constantly to confirm the airflow is stored.

The set airflow will now be maintained throughout the life of the filters. When the extraction unit can no longer maintain the set airflow an alarm will be given and the display will indicate which filter should be changed.

1)



2)



3)



Operation

5₀₃

Airflow Auto Adjust (first installation only)

When first setting the airflow on your new extraction unit the iQ will detect if the desired airflow is achievable with the installation that has been connected to the extraction unit.

If the installation is causing too much restriction for the desired airflow to be reached, the Auto Adjust feature will be activated. The procedure events are listed below.

1) The 3 buttons will begin flashing Red along with the airflow setting on the LCD screen.

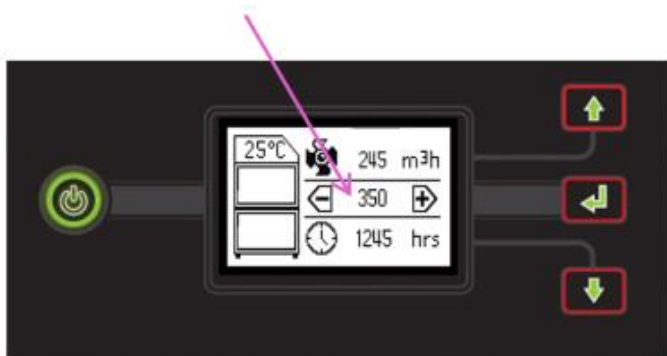

2) The airflow setting on the screen will drop to display the highest airflow that can be achieved.

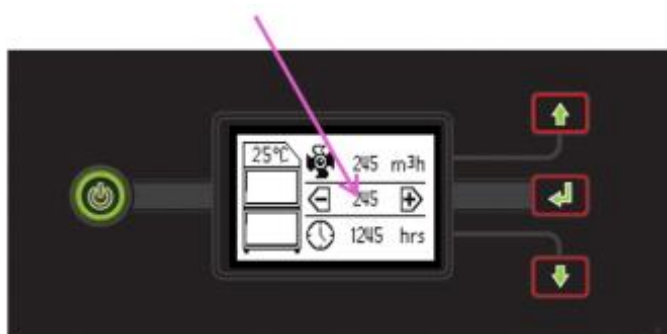

3) The airflow will stabilise and the buttons will turn green to show the airflow has set.

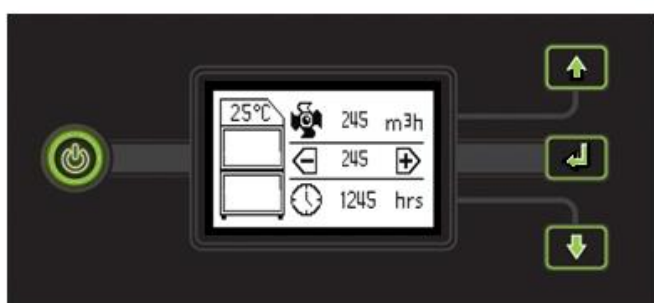

Maintenance



Maintenance UK

It is a legal requirement, under regulation 9 of the COSHH regulations that all local exhaust ventilation systems are thoroughly examined and tested at least once every 14 months (typically carried out annually). The approved code of practice recommends that a visual check should be carried out at least once a week.

COSHH requires the annual inspection and testing to be carried out by a competent person and specifies that documentation results are recorded in a log.

Contact the seller for more information about inspection and certification.

Maintenance General

User maintenance is limited to cleaning the unit and filter replacement, only the manufacturers trained maintenance technicians are authorised to carry out component testing and replacement. Unauthorised work or the use of unauthorised replacement filters may result in a potentially dangerous situation and/or damage to the extractor unit and will invalidate the manufacturer's warranty.

Cleaning the unit

The stainless steel units should be cleaned with a proprietary stainless steel cleaner, in accordance with the manufacturer's user instructions

The powder coat finished units can be cleaned with a damp cloth and non-aggressive detergent, do not use an abrasive cleaning product as this will damage the finish.

The cooling inlets and outlets should be cleaned once a year to prevent build-up of dust and overheating of the unit.

Replacing Filters

The iQ system constantly monitors the condition of the individual filters. As the filters block the LCD display will show the relevant filter symbol filling up. (see section 1 for LCD details) Each filter symbol fills up in 5% increments, when the filter icon is filled that particular filter will need replacing.

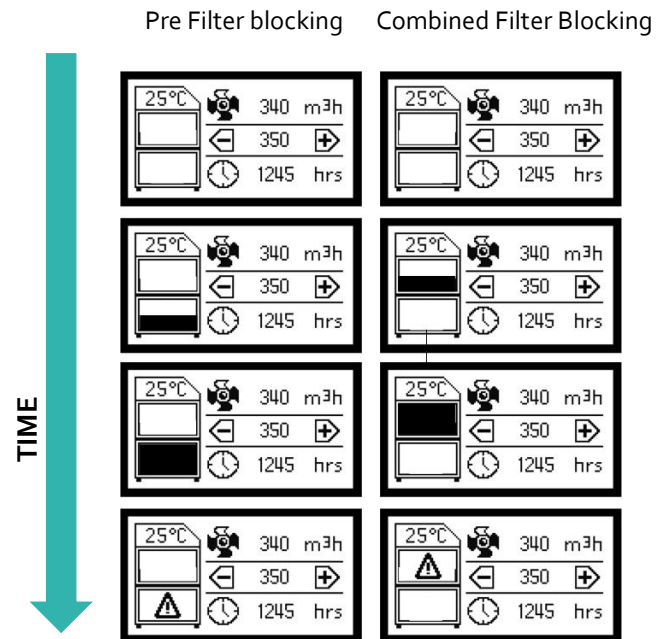

A log of the changes should be maintained by the user. The filters require attention when the display shows the filter blocked icon/ filter output signal (if fitted) or when the extractor no longer removes fume efficiently.

All filters are tested to EN1822. A certificate of conformity for each filter is available on request.

It is recommended that a spare set of filters are kept on site to avoid prolonged unit unavailability. Part numbers for replacement filters can be found on the filters fitted in your system.

To prevent overheating, units should not be run with a blocked filter condition, or with dust obstruction of Inlets / Outlets.

75% filter blocked indication

When the filters become 75% blocked the buttons on the front of the extraction unit will turn from Green to Amber and if fitted the iQ system will output a signal to indicate this. At this time it is recommended spare filters are available as a change may be needed shortly.

Maintenance

6₀₂

Pre Filter Replacement

The Pre filter needs replacing when the display flashes between the 2 images shown below, at this point the buttons will glow Red and if fitted the filter blocked signal will be given.

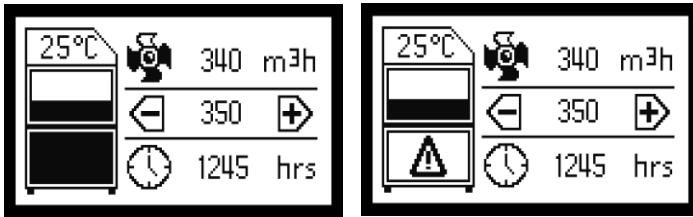

To remove and replace the Pre filter follow the procedure detailed below.

1. Isolate the electrical supply to the extractor
2. Undo the catches on the front of the unit and open the door.
3. The Pre filter is the lower of the 2 filters (refer to section 1 for filter location) using the handle on the front of the filter, pull it out of the unit.
4. Once removed it is recommend that the used filters are bagged and sealed.
5. Slide the new filter into position making sure it is pushed all the way in and is located correctly on the spigot in the back of the unit.
6. Close the door and fasten the 2 latches.

Combined Filter Replacement

The Combined filter needs replacing when the display flashes between the 2 images shown below, at this point the buttons will glow Red and if fitted the filter blocked signal will be given.



To remove and replace the Combined filter follow the procedure detailed below.



Warning

The combined filter is very heavy (Over 40Kgs) therefore the procedure below must be carried out by 2 people lifting together.

1. Isolate the electrical supply to the extractor
2. Undo the catches on the front of the unit and open the door.
3. The Combined filter is the higher of the 2 filters (refer to section 1 for filter location) rotate the lever below the filter through 180° to lower the combined filter.
4. Using the handle on the front of the filter, pull it out of the unit being careful to support it as it comes free as it is heavy.
5. Once removed it is recommend that the used filters are bagged and sealed.
6. Slide the new filter into position making sure it is pushed in all the way.
7. Rotate the lever back through 180° to raise the filter into position.
8. Close the door and fasten the 2 latches
9. Reconnect the power supply

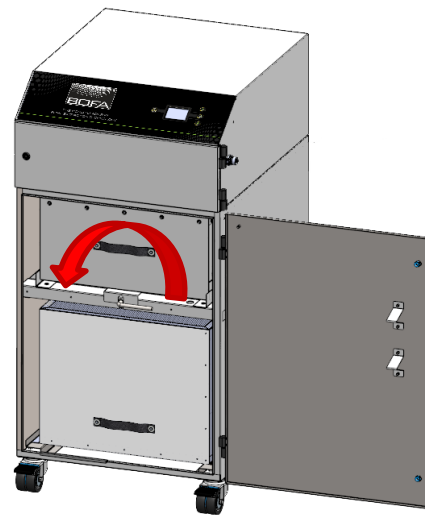

Both filters **MUST** be fitted when the extractor is in use, if the combined filter is not installed correctly the iQ system will not allow the motor to operate.

iQ System Display



iQ Display Features

The iQ display has the ability to display all the faults associated with your extraction unit. The image below shows an example of some of the fault icons that may appear in the alarm window of the LCD display.



Visual Alarms on the iQ system

The iQ system can visually display a wide range of alarms on its LCD panel. The visual displays, meanings and solutions are detailed below. All alarms will trigger the system alarm interface output signal and the inbuilt audible buzzer, if fitted/ activated.

Over Temperature Alarm

If the iQ system detects an internal temperature greater than 60°C then it will automatically shut down the extractor to prevent damage to components within the extractor.

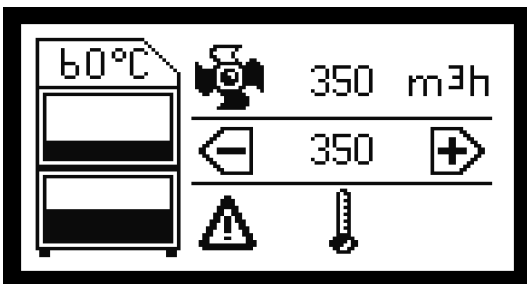

Once the internal temperature has dropped by 5°C the extraction unit will be able to restart.

To restart the extractor after an over temperature alarm the unit needs to be placed in Standby mode then powered on again.

Hose blocked alarm

The iQ system features a 2 stage Hose blocked alarm.

- Partial hose blockage
- Full hose blockage

Partial hose blocked alarm

This alarm will become active when the iQ system detects a part blockage in the installation. The iQ system interprets a partial blockage as a vacuum spike within the ductwork but is only a partial blockage as the extractor is still able to maintain its set airflow.

During this time it is normal to hear the motor increase in speed. The blockage will need to remain in the ductwork for over 5 seconds before the alarm is given.



Full hose blockage

This alarm will become active when the iQ system detects a full blockage in the installation. The iQ system interprets a full blockage as a vacuum spike within the ductwork and is considered a full blocked as the extractor cannot maintain the set airflow with the blockage present.

During this time it is normal to hear the motor increase in speed. The blockage will need to remain in the ductwork for over 5 seconds before the alarm is given.



To remove the blockage, isolate the extraction unit from the mains, remove the flexible hose, locate and remove the blockage then reattach the hose as previously installed.

iQ System Display



Heat Detection Shut off

The AD500 iQ system has an internally mounted thermal trip. That detects the temperature in the filter compartment. If the temperature rises above 55°C then the extraction unit will automatically shut down the motor and display the symbol below.

If this symbol is displayed the unit should be totally isolated from the mains supply and the unit should be fully inspected for evidence of the temperature rise. (Including inside the Pre filter)

Once the unit is safe to turn back on and the internal temperature has dropped below 50°C the thermal trip can be reset. To do this follow the procedure below.

1. Isolate the supply from the extractor
2. Open the front door & remove the Combined Filter
3. Locate the circular cut out in the shelf, at the front of the unit.
4. Inside the cut out there is a small red button that can now be pressed back in.
5. Re-fit the Combined Filter, close the front door and re connect the mains supply.



Gas Filter monitoring (VOC Sensing)

If the VOC (Volatile Organic Compound) sensing option has been fitted to your iQ system then this will be constantly monitoring the exhaust gas of the extraction unit.

If the VOC level in the exhaust exceeds the PPM (Parts per million) level pre-set at BOFA then the Gas alarm will be triggered and display the Gas icon as shown below.



Removing the Gas alarm warning

The VOC option is a perfect way to monitor how the carbon section of the combined filter is performing. Once the carbon within the filter is saturated the VOC sensor will alarm. At this point the extractor should be isolated from the mains and a new combined filter fitted. Once a new filter is installed the alarm will clear.

Run Safe Feature

To ensure personnel protection and avoid damage to the unit the iQ system will automatically shut down 5 seconds after no combined filter is detected. If no combined filter is fitted the motor will stop and the display will appear as below.



To resolve this, isolate the unit, fit the combined filter (see section 6.02) and turn the AD500 iQ On.

iQ System Display

7₀₃

USB Connectivity

The iQ system is equipped with a USB drive, that operates as a 2 way device, as detailed below.

- Duplicating iQ settings
- Download iQ Data

Duplicating iQ settings (USB Upload)

This USB upload feature has been designed for customers that have multiple extractors and specific set of parameters that they wish to duplicate across their iQ extraction units. The Procedure for duplicating extractor settings is detailed below.

1. Obtain the memory stick file from the seller (if specification has been pre-arranged with the seller)
Or download original settings from your master iQ unit
(Max capacity USB Stick 4GB)
2. Download this file to a blank memory stick
3. Place the iQ system in standby mode (Front power button glowing Red)
4. Open the front door and insert the memory stick into the USB slot
5. The LCD display will show "upload" press the button corresponding to this
6. The display will show a progress complete bar and when finished a completion "Tick"
7. The USB stick can now be removed from the unit, the door closed and the extractor turned back On



If the USB upload procedure fails the screen will display the symbol shown adjacent.

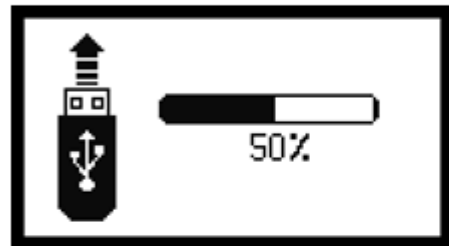
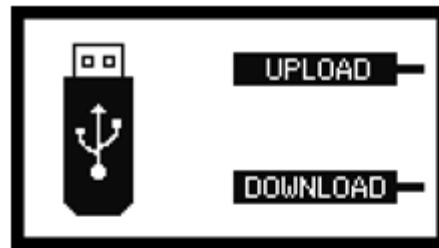
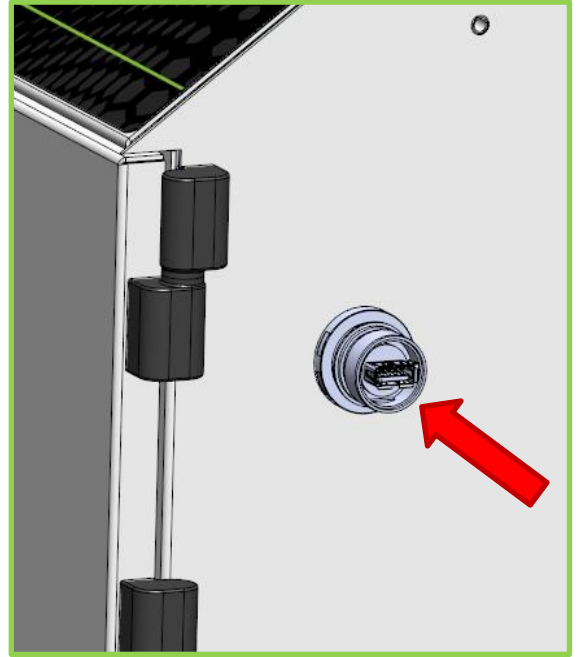

iQ System Display



Download iQ Data (USB Download)

With this feature the customer is able to download all stored data within the iQ system, this information can then be used to keep records of how your iQ system is performing, this is also very beneficial for the technical team when diagnosing issues with the extraction system. The following list shows the information available within the event log.

Downloading iQ Data

To download the information from the iQ system please follow the procedure below.

1. Obtain a memory stick (**Max capacity USB Stick 4GB**)
2. Place the iQ system in standby mode (Front power button glowing Red)
3. Open the front door and insert the memory stick into the USB slot
4. The LCD display will show "download" press the button corresponding to this
5. The display will show a progress complete bar and when finished a completion "Tick"
6. The USB stick can now be removed from the unit, the door closed and the extractor turned back On



If the USB upload procedure fails the screen will display the symbol shown adjacent.

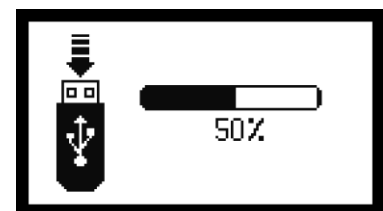
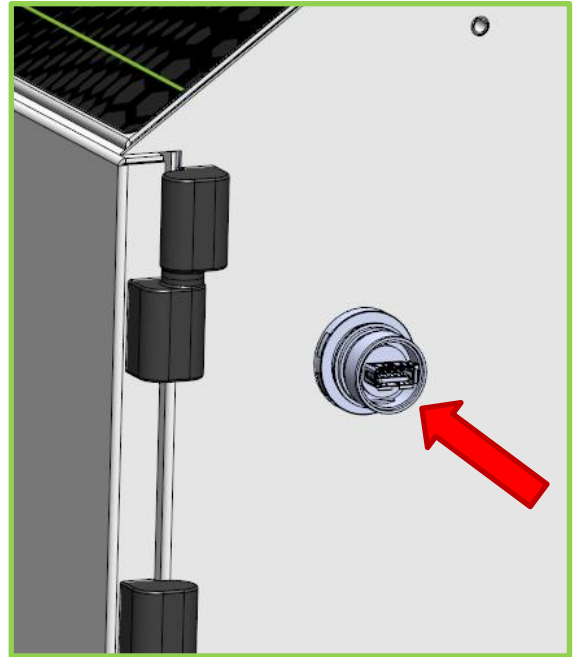

iQ System Display



The iQ system will take a snapshot of the system performance every 15 minutes or if a system adjustment is made or an alarm is triggered.

Some of the information captured is listed below..

- **Date**
- **Time**
- **Airflow**
- **Airflow Set point**
- **Pre filter % blocked**
- **Combined filter % blocked**
- **Inlet % (installation restriction)**
- **Motor output**
- **Internal Temperature**
- **Hours run**
- **Alarms**
- **Faults**

Date & Time

The date and time will be set as part of the testing stage with the manufacturer and set to GMT.

Airflow

This column shows the real time airflow through the extractor.

Airflow set point

Shows the target airflow that has been set by the user, this will record every time an adjustment is made.

Pre filter % blocked

The display on the extractor will show the pre filter blocking in 5% increments, but with this downloadable file the pre filter blockage is shown as an exact percentage of its full capacity.

Combined filter % blockage

The display on the extractor will show the combined filter blocking in 5% increments, but with this downloadable file

the combined filter blockage is shown as an exact percentage of its full capacity.

Inlet % (installation restriction)

Shows the percentage of the iQ system capacity that is taken up by the installation (pipe work) this value would also rise if the inlet or pipe work becomes blocked.

Motor output

Shows the percentage the motor is being run at to achieve the airflow set by the user. This value will increase as the filters begin to block.

Internal temperature

Shows the internal temperature of the extraction unit, the sensor is mounted to the main PCB when this sensor reaches 60°C it will shut down the extractor and a log will be recorded.

Hours Run

This is a simple hours run counter that will begin from the first time the extraction is switched on by the user. The hours run counter will only be activated when the motor is running.

Alarms

When the iQ system has an issue that requires the user to act upon this is classed as an alarm, when this occurs a code will appear in this column, the main alarm codes are listed below.

Code	Meaning
1	Door Open
4	VOC alarm
16	Over temperature
32	Inlet partially blocked
64	Inlet fully blocked
128	No combined filter fitted
512	Motor failure
2048	System 100% blocked
4096	Combined filter blocked
8192	Pre filter blocked
16777216	System 75% blocked

Faults

This column will display a code if a fault with the iQ system is detected, for analysis of any faults in this column please contact the BOFA helpline.

Troubleshooting



Fault Indication

The iQ system intelligently monitors the whole extraction unit. In the unlikely event of a problem with the extraction unit please read this section of the manual before contacting the helpline.

This section contains details on all faults the iQ system is able to display, these faults are detailed below.

Motor Failure

If the extraction unit develops a fault relating to the motor then the motor icon on the display will stop rotating and flash the airflow will read 0 m³/h.

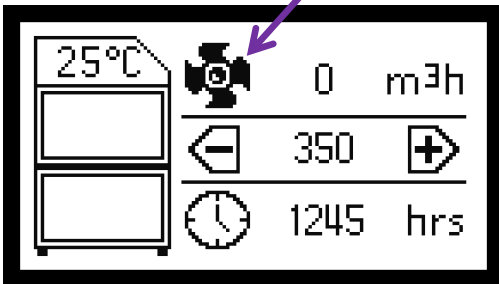

If the above symbol is displayed power should be isolated from the extractor and arrangements should be made to replace the motor.

Internal Power Supply

The extractor is fitted with an internal transformer that outputs 12V DC providing the iQ system with power. If the buttons on the front panel are not illuminated or operational this would indicate a problem with the internal power supply (provided the main isolation switch is in the ON position and voltage is proven at this point)

If the internal power supply has failed then arrangements should be made to replace the transformer.

Error Codes on the iQ display

The iQ system is able to self-diagnose problems relating directly to the monitoring system. Faults are displayed as a number in the error window within the display.

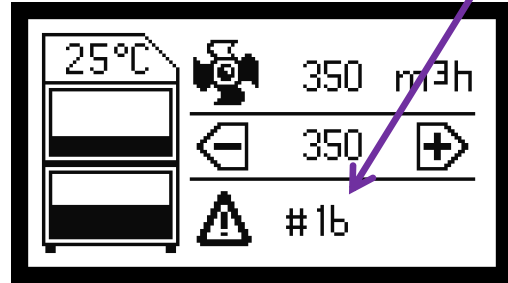

In the event of an error code being displayed please contact your local representative or BOFA who will be able to diagnose the fault and advise on the most efficient solution.

USB diagnosis

For a "Real time" event log of any faults with your iQ system please see section 7.04 & 7.05 to download a full analysis of the extraction system.

Replacement Parts



Consumable Spares

The iQ extraction system contains a pre filter and a combined filter. These should be replaced when instructed to do so by the iQ system (see section 6 for replacing the filters)

To maintain performance it is important that the filters are replaced with identical BOFA filters. To re-order please refer to the Filter number printed on the filter installed in your extraction unit.

Maintenance Protocol

The iQ data logging function enables the retrieval of filter change intervals. Users may also wish to record changes on the table below.

Unit Serial Number:			
Pre filter		Combined filter	
Date	Engineer	Date	Engineer

Filter disposal

The Pre and Combined filters are manufactured from non-toxic materials. Filters are not re-usable, cleaning used filters is not recommended. The method of disposal of the used filters depends on the material deposited on them.

For your guidance

Deposit	EWC Listing*	Comment
Non Hazardous	15 02 03	Can be disposed of as non-hazardous waste.
Hazardous	15 02 02M	The type of hazard needs to be identified and the associated risks defined. The thresholds for these risks can then be compared with the amount of material in the filters to see if they fall into the hazardous category, if so, the filters will need to be disposed of in line with the local/national regulations.

*European Waste Catalogue

System Specifications

10₀₁

Unit: AD 500 IQ

Capacity: 550m³/h (323cfm)

Weight: 142.7Kg (314.5lbs)

Motor: Centrifugal Fan

Output: 1100w

Voltage & Current: 115V/14.8A 230V/9.5A

Hertz: 50/60Hz

Noise Level: Below 60dB (A)

(at typical operating speed)

Maximum Altitude – 2000m

Size:

	Metric (mm)	Imperial (inches)
Height	1201	47.2
Depth	787	31
Width	617	24.3

Filters:

Filter Type	Surface area	Efficiency
Pre filter	30.0m ²	95% @ 0.9micron
Combined filter	7.5m ²	99.997% @ 0.3micron

Combined Filter (Gas section)

Filter Type	Carbon type	Amount
Combined filter (Gas)	Activated carbon	34kgs

Environmental operating range:

Temperature: +5°C to + 40°C

Humidity: Max 80% RH up to 31°C

Max 50% RH at 40°C

Contact Information

BOFA Headquarters

19-20 Balena Close
Creekmoor industrial Estate
Poole
Dorset
BH17 7DU
UK

Phone: +44 (0) 1202 699 444

BOFA Americas

303 S.Madison Street
Staunton
Illinois
62088
USA

Phone: +1 (618) 205 5007

BOFA International GmbH

Sudring 62
D-21465
Wentorf bei Hamburg
Germany

Phone: +49 (0) 40 7393735-15